



ITEM	SPECIFICATION	
Clear-Span Width	66' (20m)	
Eave Height	13' (3.97m)	
Ridge Height	23'11" (7.31m)	
Roof Pitch	20°	
Bay Distance	16' 5" (5m)	
Longest Component	35' 1" (10.7m)	
Minimum Tent Length	16' 5" (5m)	
Maximum Tent Length	No Limit	
Roof Fixing	Bar Tensioning	
Main Profile	9.8" x 4.7" x 0.15" (250 x 120 x 4mm)	
Max Allowed Windspeed	50mph (80km/hr)	
Eave Connection	Hot-dip galvanized steel insert	
Framework Material	Hard pressed extruded aluminum 6061/T6 (13HW)	
Cover Material	850gsm White or Colored PVC	650gsm White PVC
Wall Fabrics	950gsm Clear PVC	850gsm Colored PVC 950gsm Clear PVC
Printing	Full Roof Digital Printing available	
Certification	Engineer Structural Certificate, Resistance of Fabrics to Water Penetration Test, Ultra Violet Protection Test, Fire Action Analysis	
Warranty	10 Year Frame / 3 Year Fabric	

ACCESSORIES

- Accessories
- PVC Window Sidewalls
- Rain Gutter
- Lining & Curtains
- Glass & Aluminum Door Units
- Hard Walling System
- Glass Walling System
- Transparent PVC Cover & Sidewall
- Flooring Systems
- Weight Plate

AVAILABLE COLORS

*additional cost may be applicable and subject to availability



FRAMEWORK & MAIN PROFILES

9.8" x 4.7" x 0.15" (250 x 120 x 4mm)

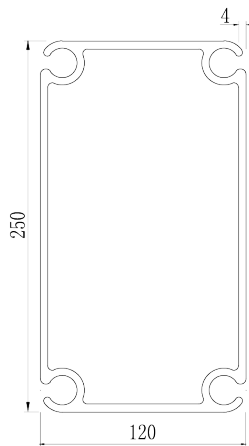

1. Main Profile

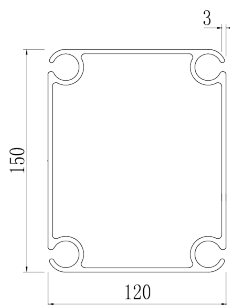

2. Gable Upright

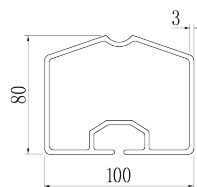

3. Eave Purlin

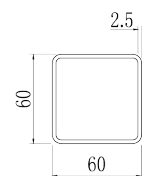

4. Roof Purlin

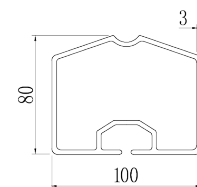

5. Gable Eave Rail

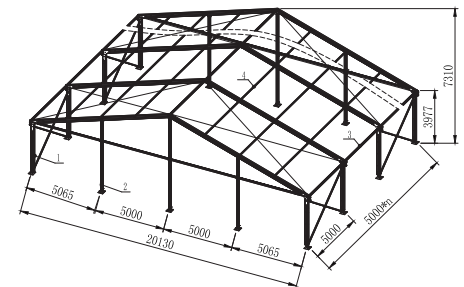

We Design | We Manufacture | We Sell | We Deliver America Wide
www.extremecanopy.com admin@extremecanopy.com (888) 201 1968

STYLES AVAILABLE

A FRAME

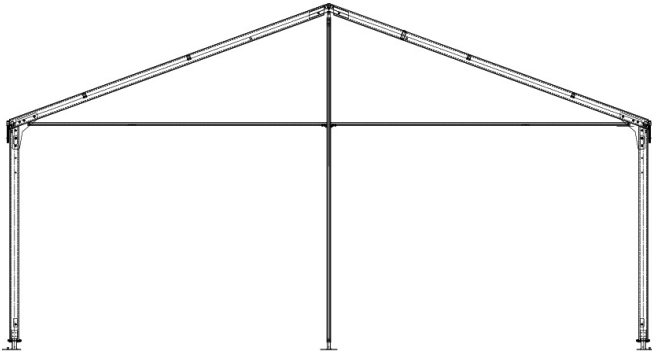

ACRUM

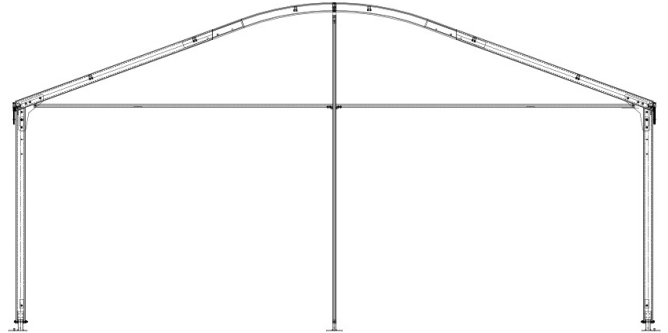

SPANS AVAILABLE

66' GABLE SPAN

